

Rivetwise[®]

GRIPCO[®]

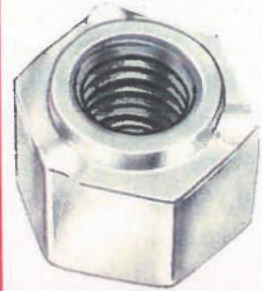

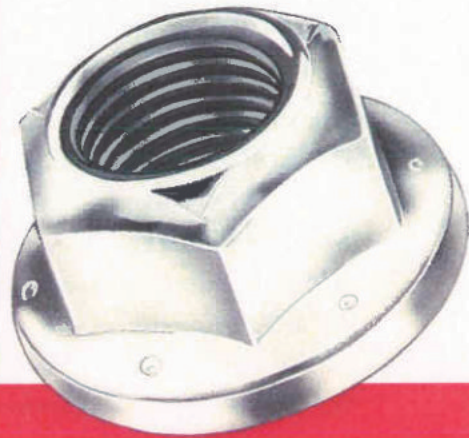
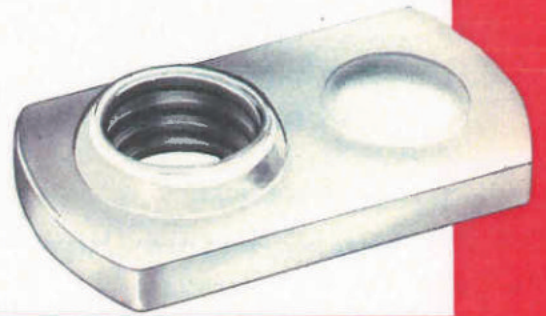
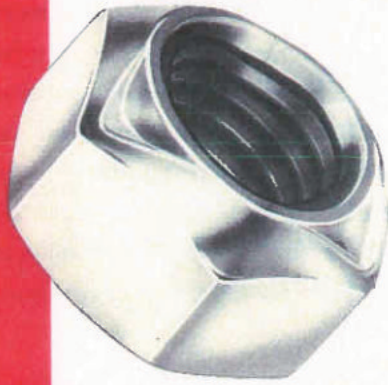
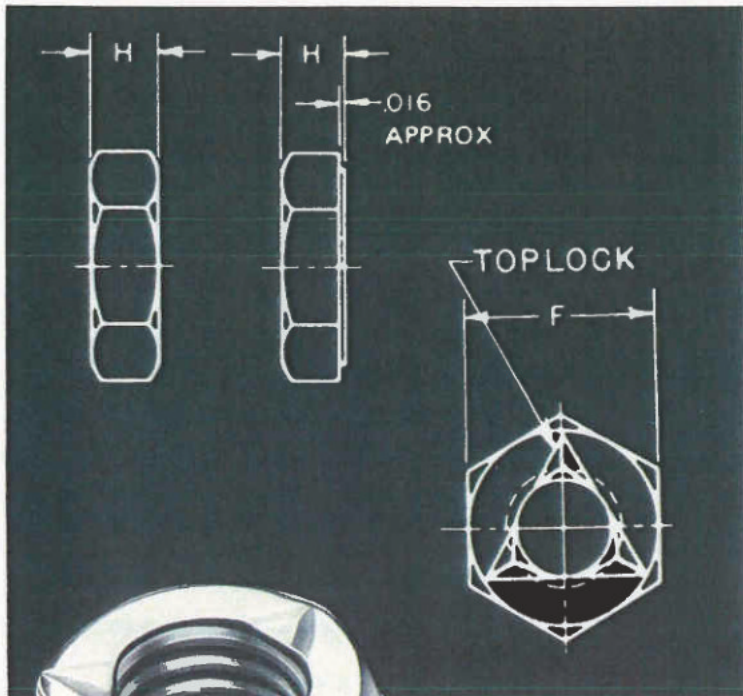

TOPLOCK NUTS

Jam and Machine Screw Series

The Gripco Toplock Nuts are manufactured from low carbon steel to meet Grade A performance specifications. These prevailing torque nuts are designed for use in non-critical applications with Grade 2 bolts.

- Jam and Machine Screw Toplock Nuts are available.
- No markings are required for this series of nuts.
- Parts are furnished with a cadmium and wax finish or as requested.
- Gripco Toplock Nuts meet or exceed all current I.F.I. specifications.

TOPLOCK NUTS JAM AND MACHINE SCREW SERIES

Machine Screw Series

SIZE	COARSE PART NO.	F WIDTH ACROSS FLATS		THICKNESS		CARTON QTY.	WEIGHT PER M
		MAX.	MIN.	MAX.	MIN.		
6-32	TLM-0632-S	.312	.302	.114	.102	30,000	2.0
8-32	TLM-0832-S	.344	.332	.130	.117	23,000	2.8
10-24	TLM-1024-S	.375	.362	.130	.117	20,000	3.3
12-24	TLM-0224-S	.437	.423	.161	.148	11,000	5.6

Finished Hexagon Jam Nut Series

SIZE	COARSE PART NO.	SIZE	FINE PART NO.	F WIDTH ACROSS FLATS		H THICKNESS		CARTON QTY.	WEIGHT PER M
				MAX.	MIN.	MAX.	MIN.		
1/4-20	TLF-1420-S-JAM	1/4-28	TLF-1428-S-JAM	.438	.428	.164	.150	13,000	5.0
5/16-18	TLF-5618-S-JAM	5/16-24	TLF-5624-S-JAM	.500	.489	.195	.180	8,000	7.2
3/8-16	TLF-3816-S-JAM	3/8-24	TLF-3824-S-JAM	.563	.551	.227	.210	6,000	10.3
7/16-14	TLF-7614-S-JAM	7/16-20	TLF-7620-S-JAM	.688	.675	.260	.240	3,000	18.4
1/2-13	TLF-1213-S-JAM	1/2-20	TLF-1220-S-JAM	.750	.736	.323	.302	2,200	25.6
5/8-11	TLF-5811-S-JAM	5/8-18	TLF-5818-S-JAM	.938	.922	.387	.363	1,100	48.2



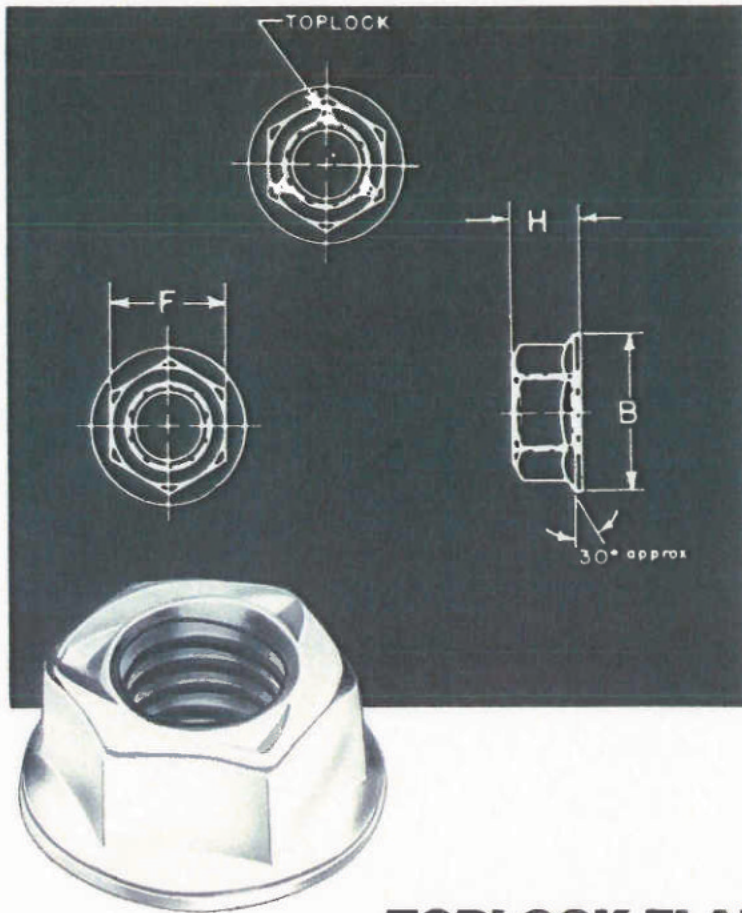

Grade A TOPLOCK FLANGE NUTS

The Gripco Toplock Flange Nuts are manufactured from low carbon steel to meet Grade A performance specifications. These prevailing torque nuts are designed for use with Grade 2 bolts.

- No markings are required for this series of nuts.
- Parts are furnished with a cadmium and wax finish or as requested.
- Gripco Toplock Flange Nuts meet or exceed all current I.F.I. specifications.
- Prices and samples are available upon request.

TOPLOCK FLANGE NUTS GRADE A

SIZE	COARSE PART NO.	SIZE	FINE PART NO.	(F) WIDTH ACROSS FLATS		(H) THICKNESS		(B) FLANGE DIAMETER		CARTON QTY.	WEIGHT PER M
				MAX.	MIN.	MAX.	MIN.	MAX.	MIN.		
8-32	TLNF-0832-S			.344	.334	.203	.187	.469	.452	8,500	5.2
10-24	TLNF-1024-S	10-32	TLNF-1032-S	.375	.365	.219	.203	.500	.480	7,000	6.0
12-24	TLNF-0224-S			.438	.428	.236	.222	.594	.574	4,500	9.9
1/4-20	TLNF-1420-S	1/4-28	TLNF-1428-S	.438	.428	.236	.222	.594	.574	4,500	9.2
5/16-18	TLNF-5618-S	5/16-24	TLNF-5624-S	.500	.489	.283	.268	.680	.660	3,000	13.5
3/8-16	TLNF-3816-S	3/8-24	TLNF-3824-S	.562	.551	.347	.330	.750	.728	2,000	19.1
7/16-14	TLNF-7614-S	7/16-20	TLNF-7620-S	.688	.675	.395	.375	.937	.910	1,200	35.5
1/2-13	TLNF-1213-S	1/2-20	TLNF-1220-S	.750	.736	.458	.437	1.031	1.000	750	47.1

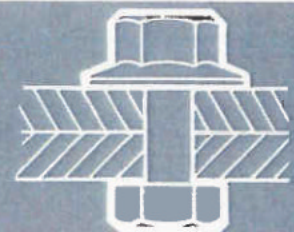
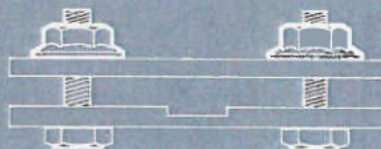

WARRANTY POLICY

In cases where Gripco products are either heat treated, welded or given a protective coating following delivery to the purchaser, the Gripco Fastener Division shall not be held responsible for failures of the product to meet dimensional, mechanical or performance requirements.

RETURNED GOODS POLICY

The return of goods by customers will not be allowed without prior written authorization. Please contact the South Whitley sales office with any request for the return of material.

QUALITY ASSURANCE POLICY

Unless otherwise specified by the customer at the time of the inquiry (verbal or written) or on the purchase order, parts will be processed in accordance with standard in-house procedures. Certifications require prior notification. Please contact Gripco, South Whitley sales office for additional information on your requirements.

COUNTRY OF ORIGIN

All finished products illustrated in this catalog are manufactured in the United States of America. Manufacturing facilities are located at South Whitley, Indiana and Montpelier, Indiana.

GRIPCO®

**Emhart Fastening Technologies
Industrial Division**

**510 River Road
Shelton, CT 06484
Tel. (203) 944-1711
Fax (800) 220-4286**

Canadian Office

**3545 Thimens Boulevard
St. Laurent, Quebec, H4R 1V5
Tel. (514) 333-8080
Fax (514) 338-3829**

**Emhart
GRIPCO**

A  **BLACKS DECKER** COMPANY